

DGH16J-01P-1Y-00A(H)

40.00

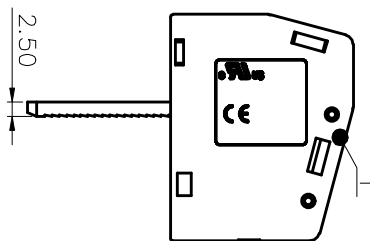

DGH16K-01P-1Y-00A(H)

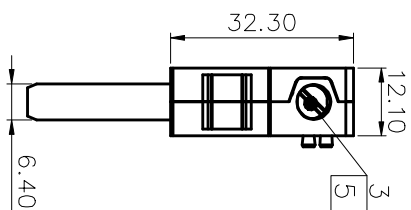
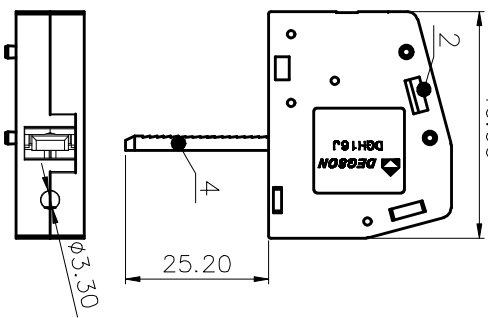
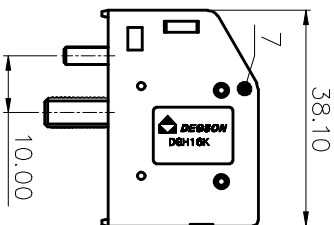
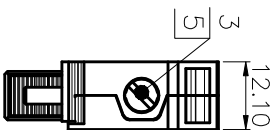
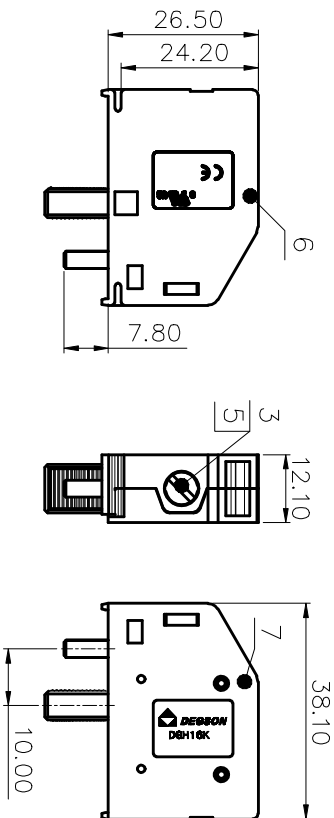

公差等级/General	Tolerances(mm)										0.1/1.0		
0	>3	>6	>10	>18	>30	>50	>80	>120	>180	>280	>315	>400	±Z
3	~	6	10	18	30	50	80	120	180	280	315	400	
	±0.12	±0.18	±0.22	±0.26	±0.31	±0.37	±0.57	±0.80	±1.05	±1.15	±1.60	±2.20	±2.50

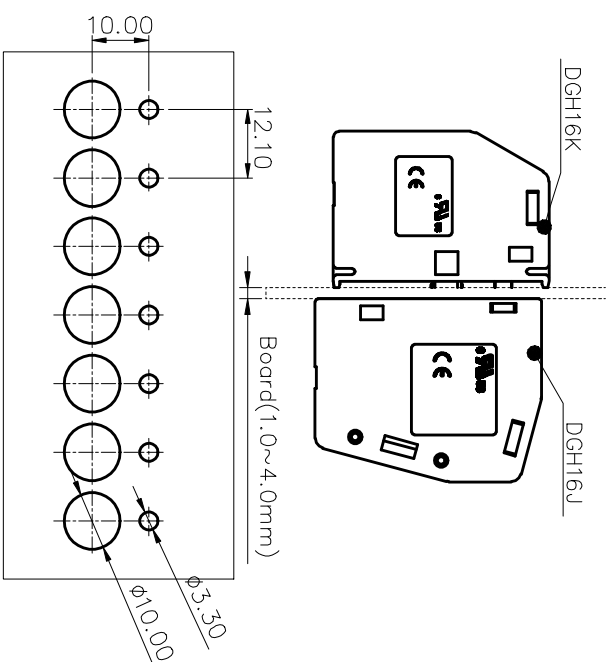

ITEM	NAME OF PART	MATERIAL	NOTES
1	Housing1	PAG6	UL94V-0
2	Housing2	PAG6	UL94V-0
3	Screw	Copper alloy	M5/Sn plated
4	Pin	Copper	Sn Plated
5	Cage	Copper alloy	M5/Sn Plated
6	Housing3	PAG6	UL94V-0
7	Housing4	PAG6	UL94V-0

REV	ECN	DESCRIPTION	DRAFT	DATE

MATERIAL:	/	NAME:	DGH16-01P-1Y-00A(H)
MAT NO.:	/	STATUS:	/
STATUS:	/	APPD:	/
CHKD:	/	DRAWING NO.:	DGH16-C01
DRAFT:	NPX 2018.06.21	TYPE:	CUSTOMER DRAWING
SIZE:	A4	SCALE:	2:1
REV	T0	SHEET	1/1

UL 标准/UL Standard:	B	C	D
额定电压/电涌/Rated Voltage(V)/Current(A)	600/85	600/85	600/5
EC 标准/EC Standard:			
过压类别/Overvoltage Category/污染等级/Pollution Degree	III/3	III/2	II/2
额定电压/电涌/Rated Voltage(V)/Current(A)	/	500/76	/
额定脉冲电压(kV)/Rate Impulse Voltage(kV)	/	6	/
拧紧扭矩(螺栓和螺线)/Wire Tightening(N·m/Lb·in)	M5, 2.0/11.54		
线径范围(硬线和软线)/Wire Range(rigid and flexible)(mm <sup>2</sup> /AWG)	0.5~1.6/20~4		
间距/Pitch(mm)/线数范围/Poles	12.10/N=01P		
剥线长度/Stripping length(mm)	16		
使用温度范围/Operating temperature(°C)	-40~+105		
符合RoHS要求/Conform to RoHS	Yes		

NINGBO DEGSON ELECTRICAL CO., LTD

DGH16-01P-1Y-00A(H)